

Konische aanslagdempers

type K/D

Art.Code	D (mm)	H (mm)	M (mm)	L Spindellengte (mm)
K2517D	25	17	M6	8 10 12 15 18 20
K4028D	40	28	M8	13 16 23 28
K4053D	40	53	M8	13 16 23 28
K5018D	50	18	M10	15 20 28 33
K5021D	50	21	M10	15 20 28 33
K5022,5D	50	22,5	M10	15 20 28 33
K5030D	50	30	M10	15 20 28 33
K5035D	50	35	M10	15 20 28 33
K5039D	50	39	M10	15 20 28 33
K6022D	60	22	M10	15 20 28 33
K7525D	75	25	M12	27 37
K7528D	75	28	M12	27 37
K8025D	vierkant 80	30	M12	32 37
K8060D	80	60	M12	37
K12545D	125	45	M16	45
K12580D	125	80	M16	45
K12590D	125	90	M16	45

Kolom L: vetgedrukt zijn voorraadmaten, overige maten zijn op aanvraag leverbaar

Materiaal: natuurrubber
Standaard leverbaar in:
 40° ± 5° Shore A
 55° ± 5° Shore A
 70° ± 5° Shore A

Type K/D

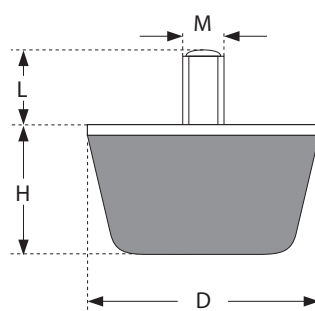

Type K/D K25 x 17

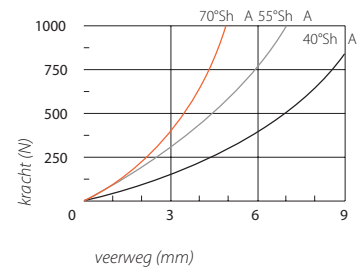

Type K/D K50 x 18

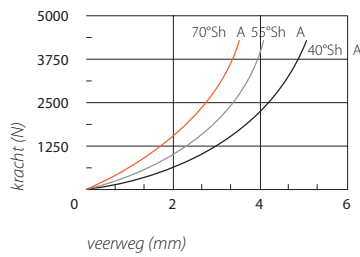

Type K/D K50 x 22,5

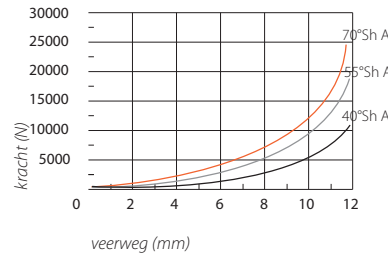

Type K/D K50 x 39

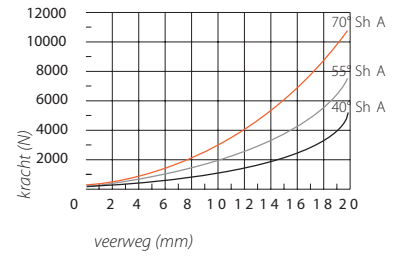

Type K/D K75 x 28

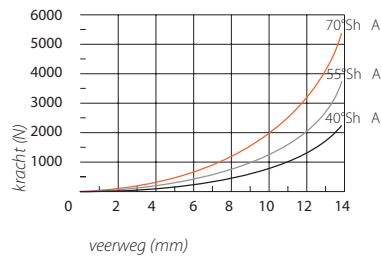

Type K/D K80 x 25

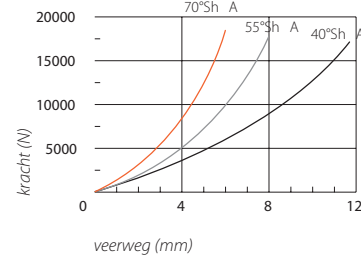

Type K/D K125 x 45

